

PERFORM
BETTER

FLOORING

Rig & Rack



Perform Better combines expertise and passion to help people become fitter, stronger and healthier. To do this, we offer high-quality products as well as customized solutions for gyms, sports clubs, personal trainers or physio practices to meet individual needs.

Our expertise and passion for training and health make us a reliable partner for anyone who wants to achieve their goals.

 [perform_better_europe](#)

 [Perform Better Europe](#)

PB FLOORING · RIG & RACK



Turf

4

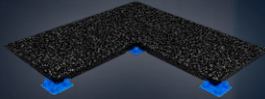

Connect

8

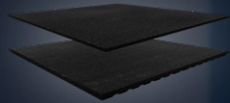

Standard

11

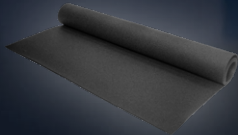

Rolling Rubber

14



Outdoor

16



Puzzles

18



RIG & Rack

21

TURF

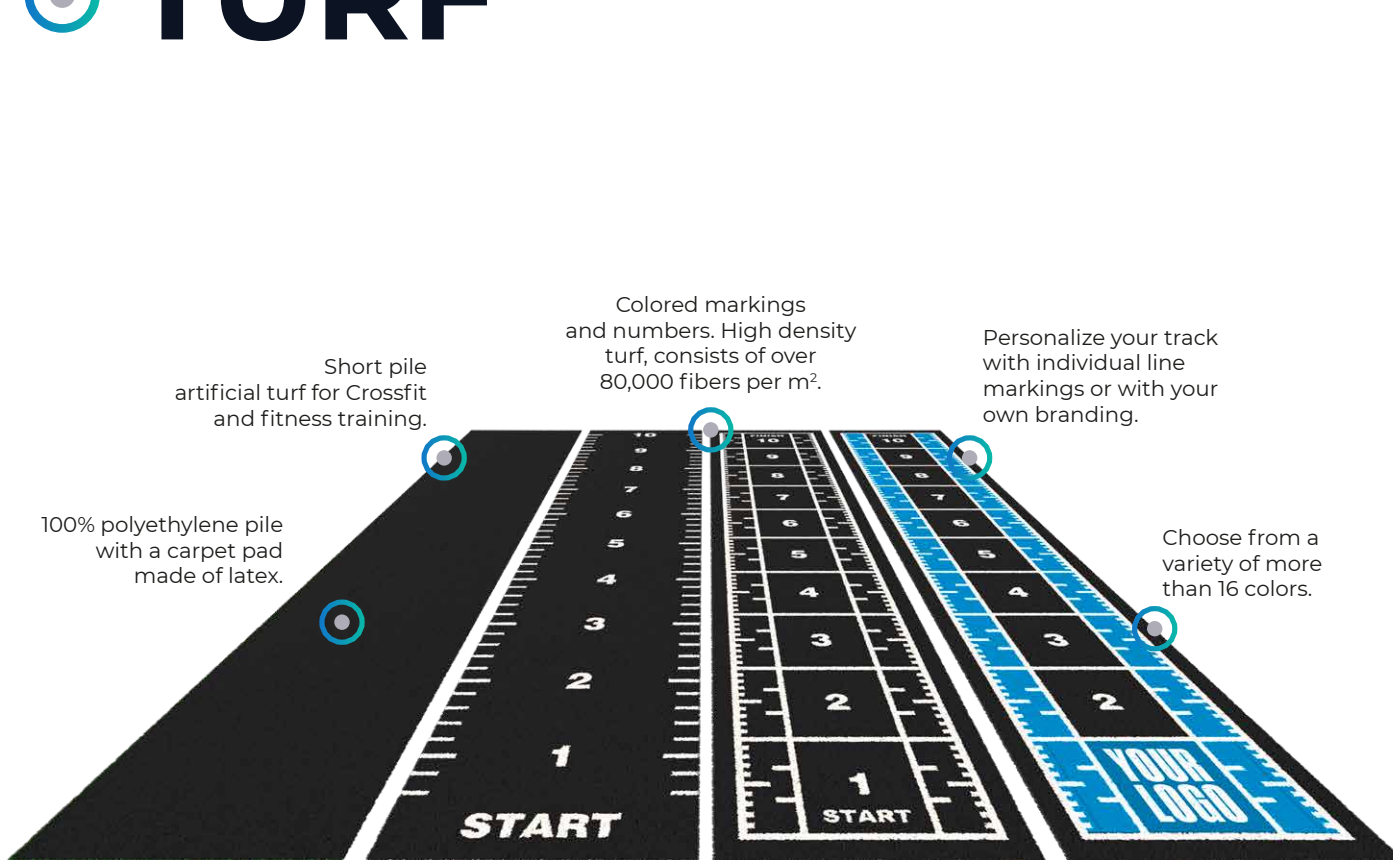

100% polyethylene pile with a carpet pad made of latex.

Short pile artificial turf for Crossfit and fitness training.

Colored markings and numbers. High density turf, consists of over 80,000 fibers per m².

Personalize your track with individual line markings or with your own branding.

Choose from a variety of more than 16 colors.

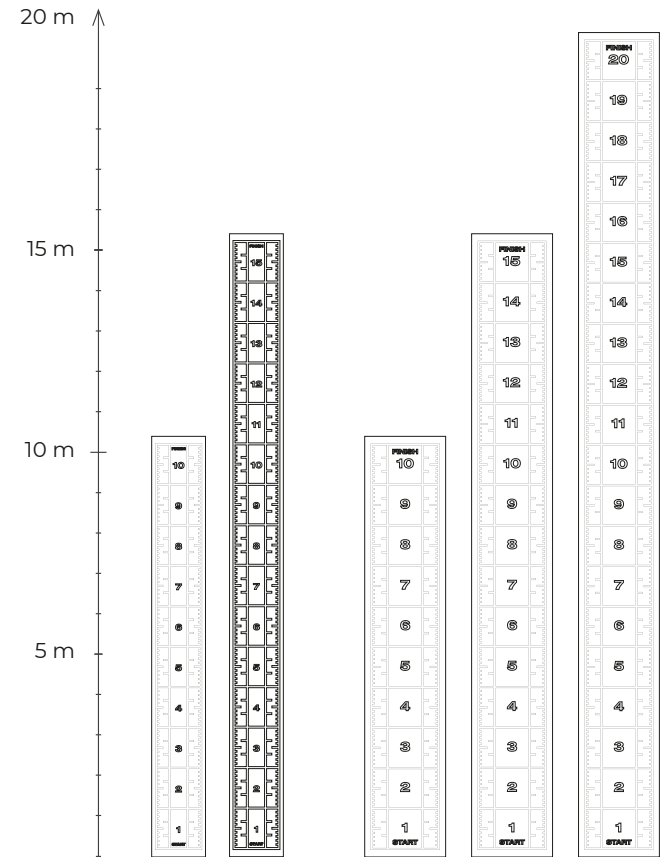

UNI RANGE

ESSENTIAL RANGE

PREMIUM RANGE

CUSTOM TURF

Wide 1,33 m

Wide 2 m

AVAILABLE COLORS



moss green



black



light grey



anthracite



yellow



brick red



bright red



blue



CUSTOM TURF

STEP 1

SHARE YOUR VISION. WE MAKE IT COME TRUE!

Describe your idea to us in as much detail as possible and we will transform your vision into a custom turf within 24 hours! Do you have specific ideas, how the markings should look like?

Should we put a START or FINISH lettering at the beginning or end of your lawn?

STEP 2

CATEGORY A:

For example, you can choose any two colors from Category A, at no extra charge:



white



moss green



black



anthracite



blue



brick red

CATEGORY B:



off-white



light grey



aqua blue



sky blue



lime green



yellow



yellow



bright red



pink



gold



choco brown

You can choose up to 6 colors per lane, should you need more than 2 colors from the category A or at least one color from category B, an extra charge will be made. Surcharge – see price calculator in our price list.

STEP 3

Send your design request to sales@perform-better.de

Send a clear sketch by e-mail (a photo with your cell phone, a PowerPoint or Excel file) and attach your personal branding or Logo as a vector file (.pdf, .ai, .eps, .svg.). In addition, a floor plan helps for an overall impression and concrete planning.

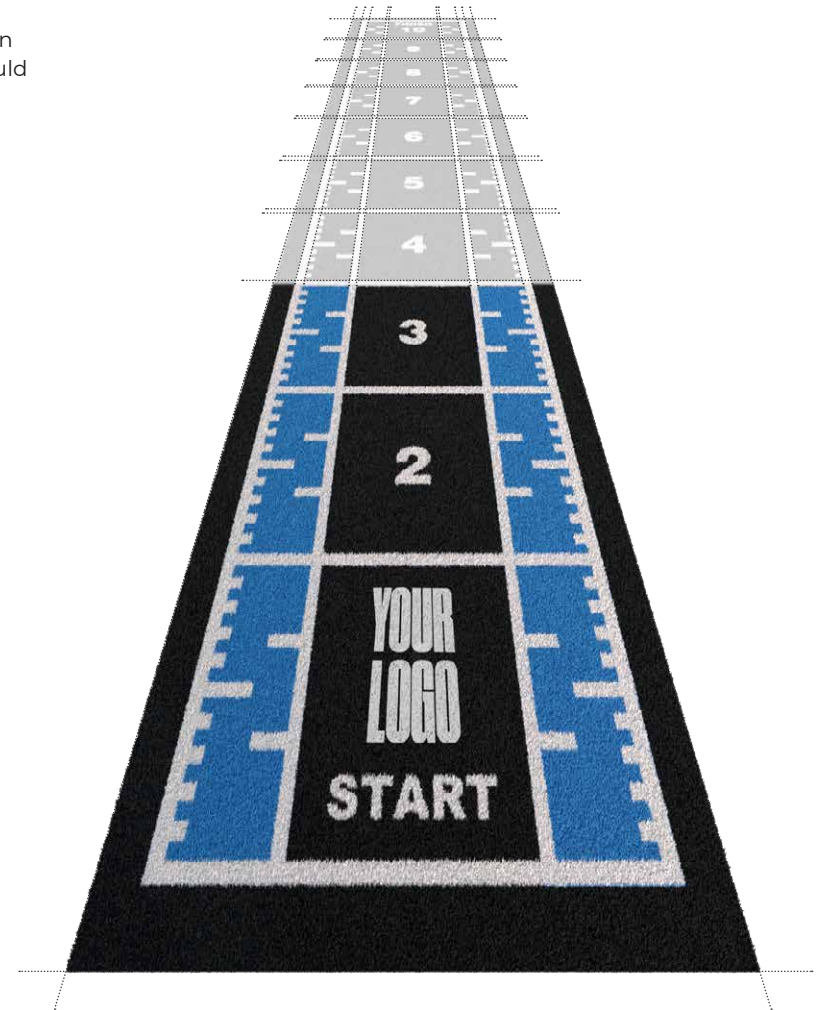



KingsBox

ASC

88:55:39

ATX
40
50

10
FB STRONG

20
FB STRONG

10
FB STRONG

20
FB STRONG

25
FB STRONG

1
2
3
4
5
6

CONNECT Tiles

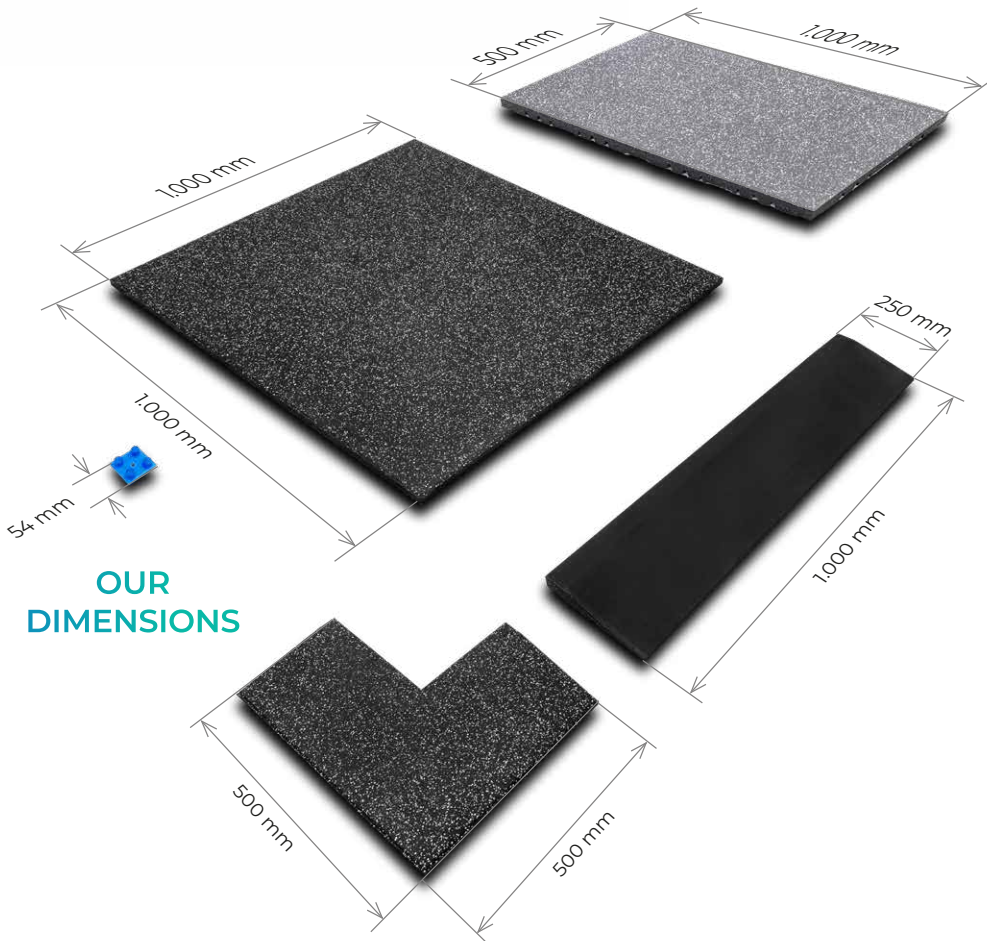

OUR DIMENSIONS

WIDE PALETTE OF COLORS

20 mm Thickness

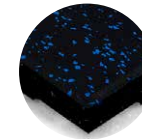

15% blue

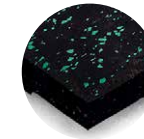

15% bright green

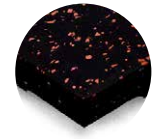

15% terracotta red

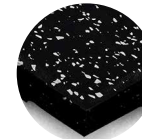

15% light grey

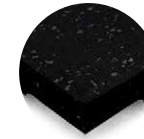

15% dark grey



STONE middle grey

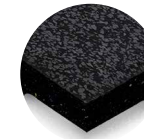

STONE dark grey



100% pure black

30 mm Thickness



15% light grey



STONE middle-grey



100% pure black

40 mm Thickness



15% light grey



STONE middle-grey



100% pure black

CONNECT (TILES)

The fitness tiles are easy to install with the help of the plug-in system, gluing is not required. The edges can be covered with a stainless steel or aluminum profile. can be covered.

The tiles can be easily cut to the right size with a hand knife, although we recommend the use of carpet knives (cutters). Use a Rubber mallet to close the joints.

THE CONNECTION SYSTEM

A „connector“ (connector) is placed every 20 centimeters, resulting in an average use of 5 connectors per meter. This and the fact that our connectors are made of polypropylene, ensures that the tiles stay perfectly in place after connecting.

The result is a phenomenal, free-floating system that can be installed without the need for adhesives or other complicated installation methods.

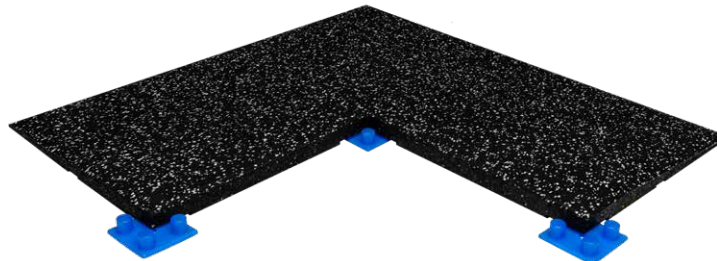

SIDE VIEW + CONNECTORS



VIEW FROM BELOW + CONNECTORS

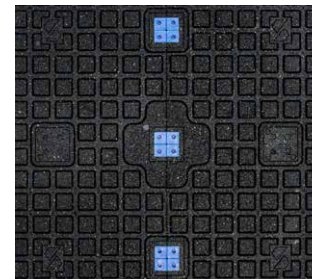
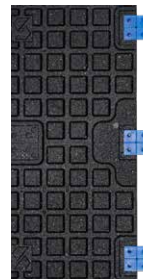
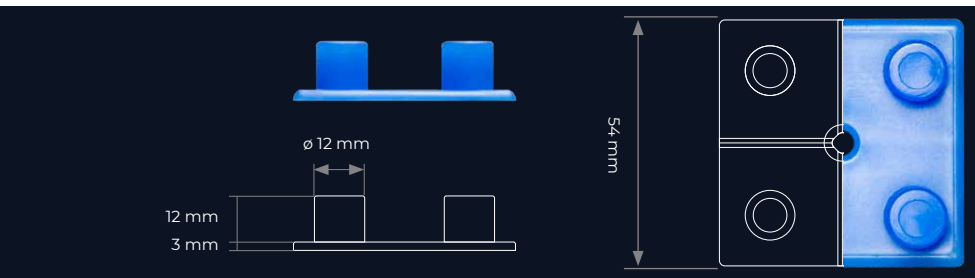
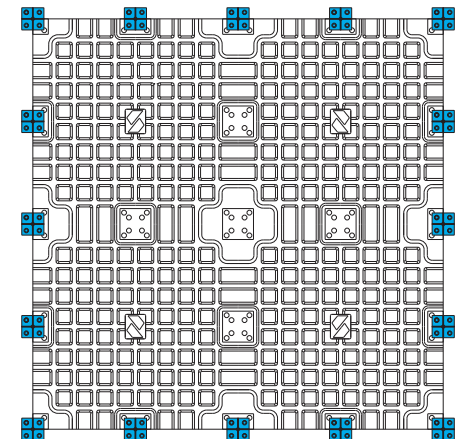

ADVANTAGES



EASY TO CLEAN



EASY TO INSTALL



COMPREHENSIVE 5-YEAR WARRANTY



ACOUSTICAL QUALITIES



STANDRARD Tiles

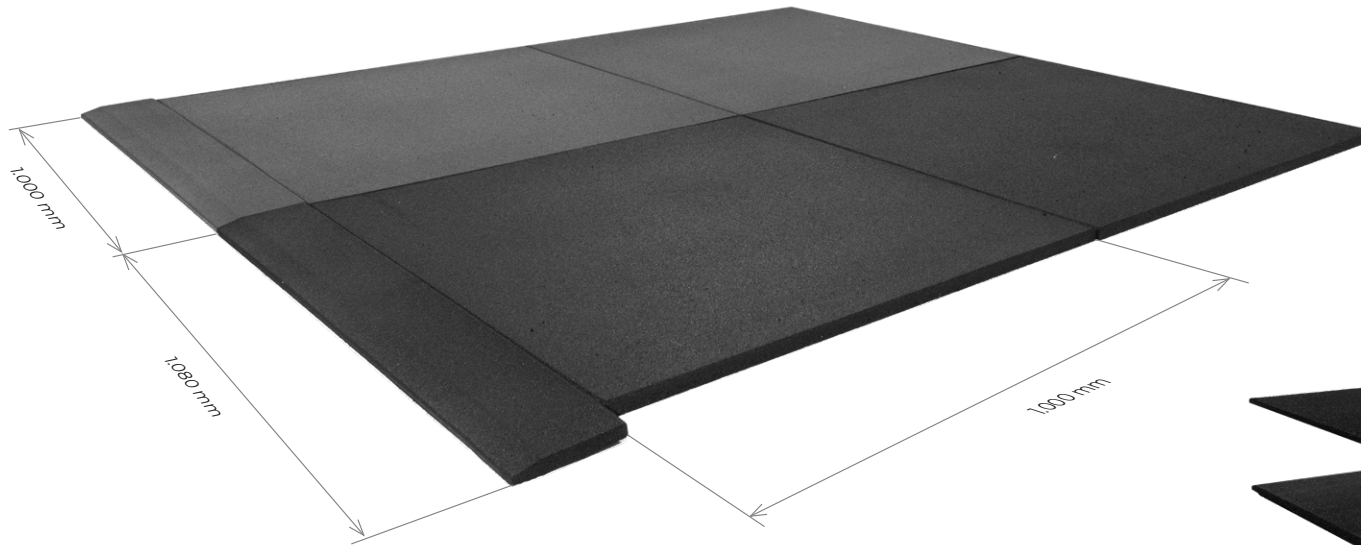

The highly shock-absorbent recycled rubber fitness tiles are manufactured and designed for any open space and/or functional area. The standard rubber tile has a 2-layer system; the bottom layer is made of coarse granules and the top 5 mm layer is made of finer granules. These tiles are manufactured in the EU and are made exclusively from recycled European car tires, which are bound with PU. Due to the exclusive use of high quality raw material, our standard tiles are almost odorless, which makes them suitable even for small, enclosed spaces.

Our new hygiene-only addition to the standard tile range offers additional protection against the spread of bacteria and viruses.

OUR COLOURS

Black



20 mm

30 mm

43 mm

53 mm

63 mm

Gray

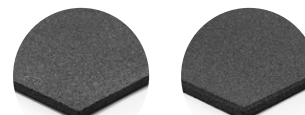

15 mm

20 mm

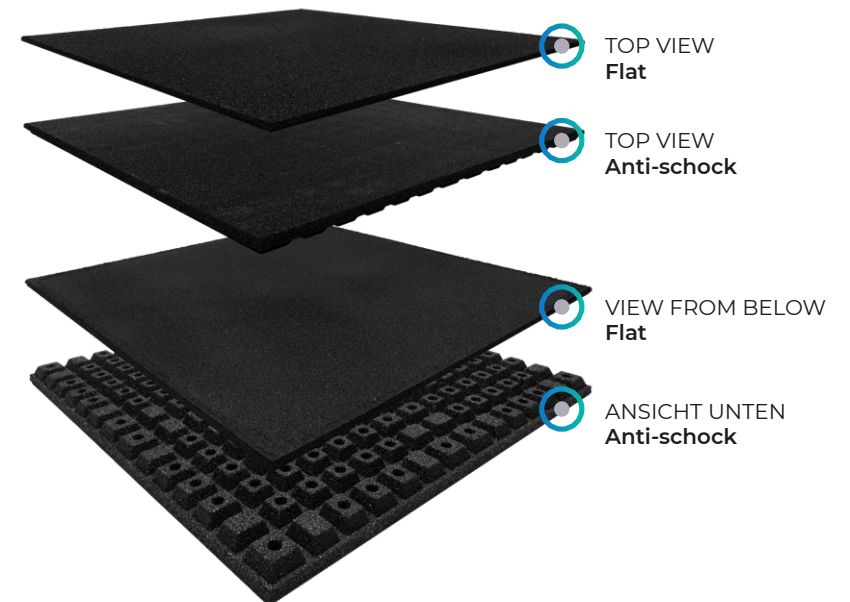
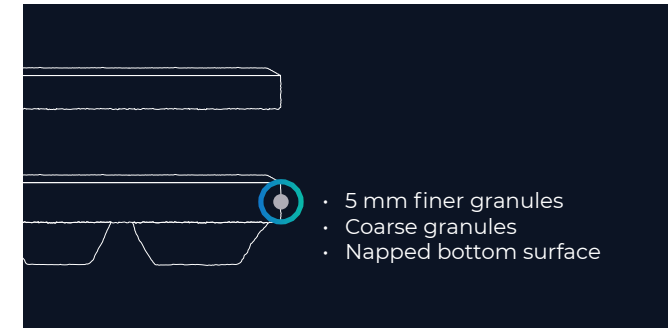

THE UNDERSIDES

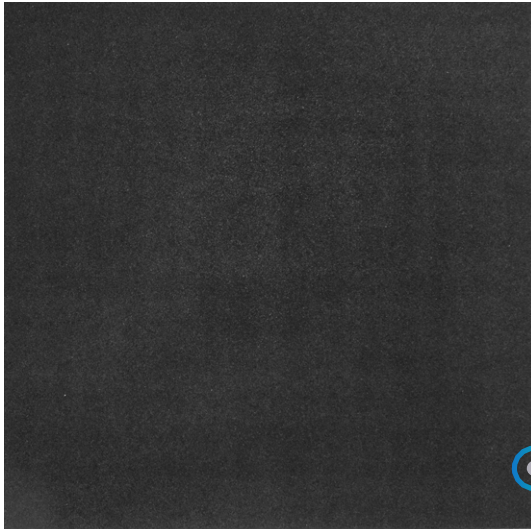

FLAT

A completely flat surface that offers excellent available thicknesses offers excellent durability.

AVAILABLE THICKNESSES

- 11 mm
- 15 mm
- 20 mm
- 30 mm



Fig.: Standard tile/flat/black - 1,000 x 1,000 mm

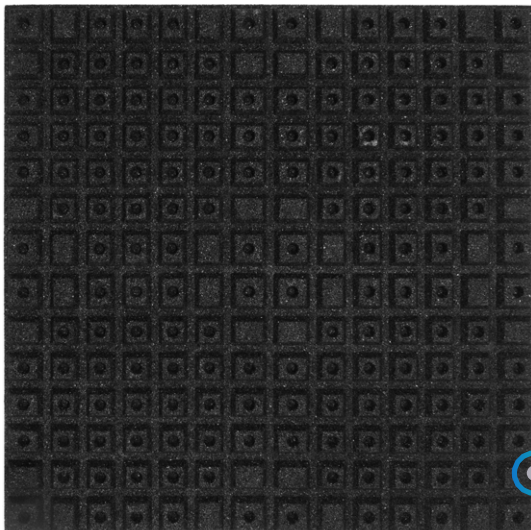

ANTI-SHOCK

Our anti-shock floor is designed to absorb even more sound (for example, impact sound).

AVAILABLE THICKNESSES

- 43 mm
- 53 mm
- 63 mm



Fig.: Standard Tile/Anti-Shock/Black - 1,000 x 1,000 mm

ADVANTAGES

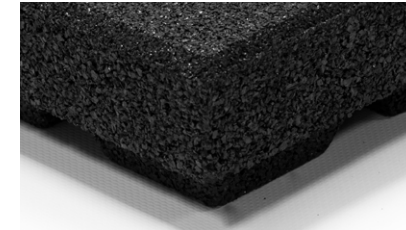

HIGH DENSITY



MADE IN EUROPE



100% RECYCLED RUBBER USED



ODORLESS

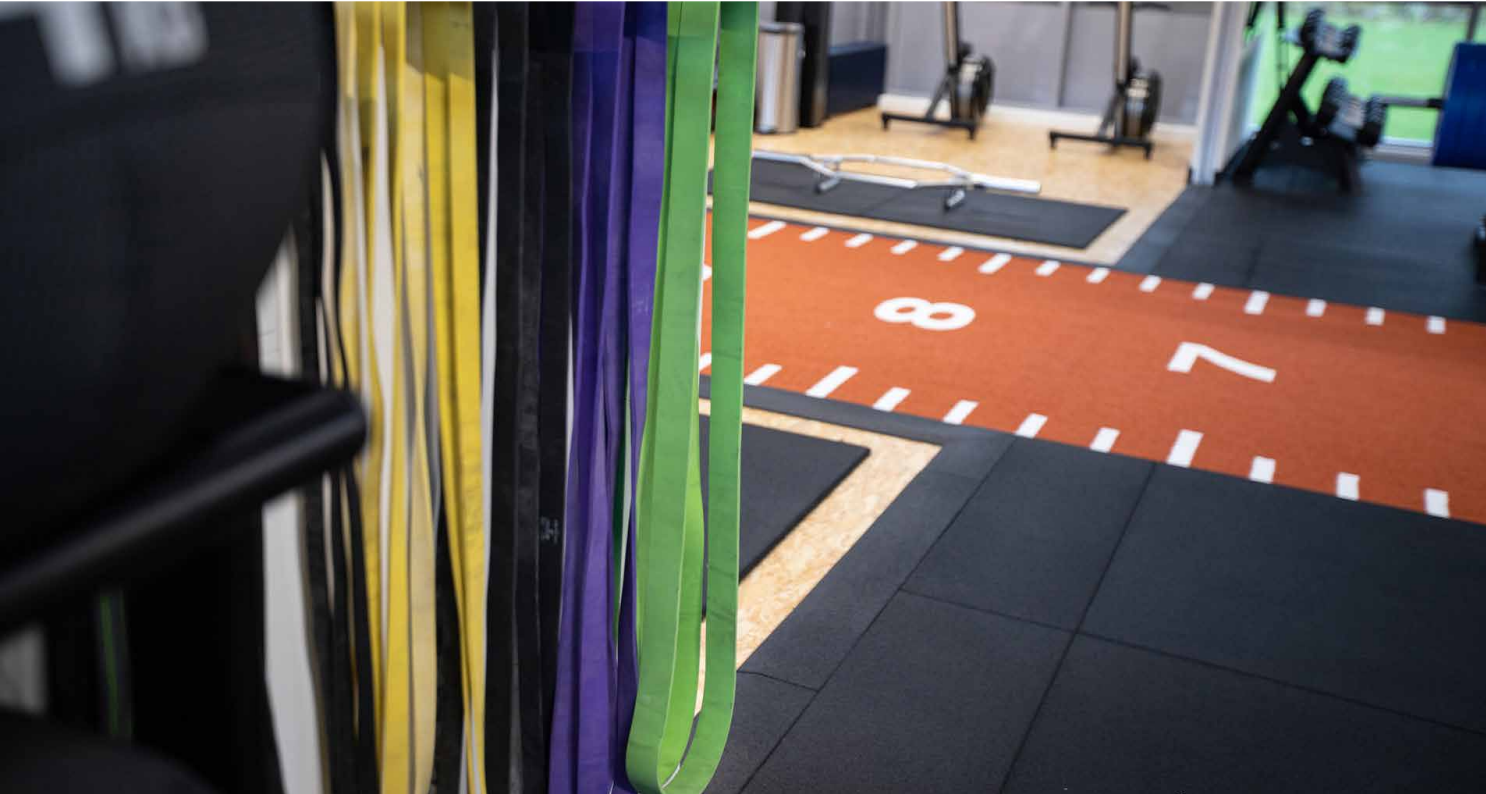
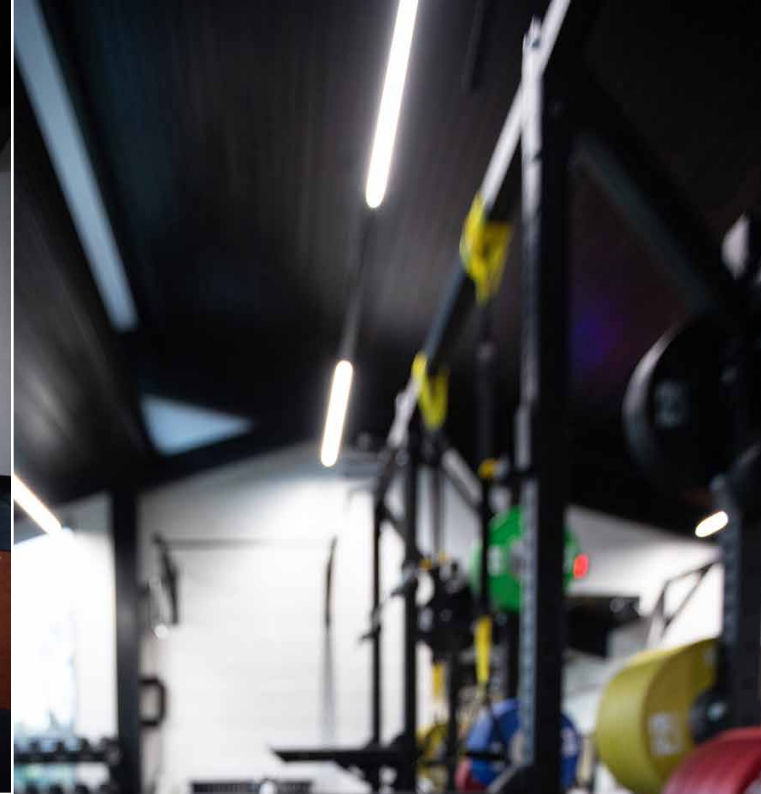

ROLLING RUBBER

The rolled goods are made from predominantly recycled black rubber particles from truck tires - the colored versions have a variants have a proportion of new EPDM. As a result of the exclusive use of tires, this flooring has a very fine, smooth surface. surface.

Our highly compact and maximally robust rubber floor covering is immune to moisture and water, elastic, impact sound absorbing and is suitable for a wide range of applications:

Exhibitions, trade shows and exhibition stands, fitness centers, Crossfit-Boxes, recreation rooms, sports centers, dressing rooms, ice rinks, mountain resorts, shooting ranges, horse transport, rooms of of golf courses, etc.



OUR COLOURS

PURE BLACK

SBR rubber granulate bonded with PUR



black

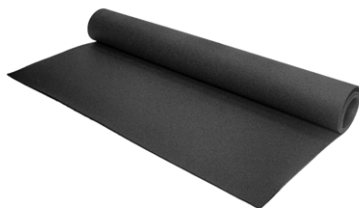

FIVE

95 % SBR and 5 % EPDM rubber granules, bonded with PUR

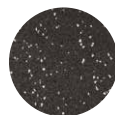

grey

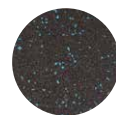

blue



lila

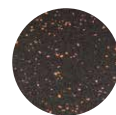

orange

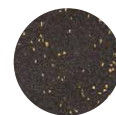

yellow

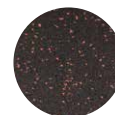

red



samba



stars

DENSITY

Our rolling floors are available in a thickness suitable for any purpose. From 4 mm up to 14 mm in 2 mm increments.

Our standard roll width is 1.25 meters.



4 mm
Cardio training, spinning, physiotherapy, yoga, exhibition, substrate protection etc.



6 mm
gym, aerobics, shooting range



8 mm
Functional training, martial arts



10 mm
Ice skating rink, mountain/cable car station, ski rental, free weight areas middle weights

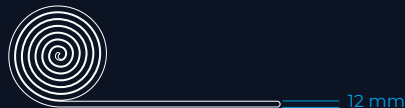

12 mm
Free weight areas heavyweight, CrossTraining

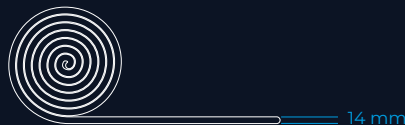

14 mm

ADVANTAGES

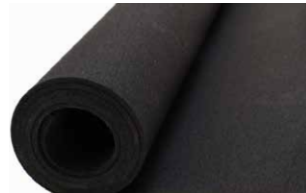

HIGH DENSITY



MADE IN EUROPE



100% RECYCLED RUBBER USED



ODORLESS

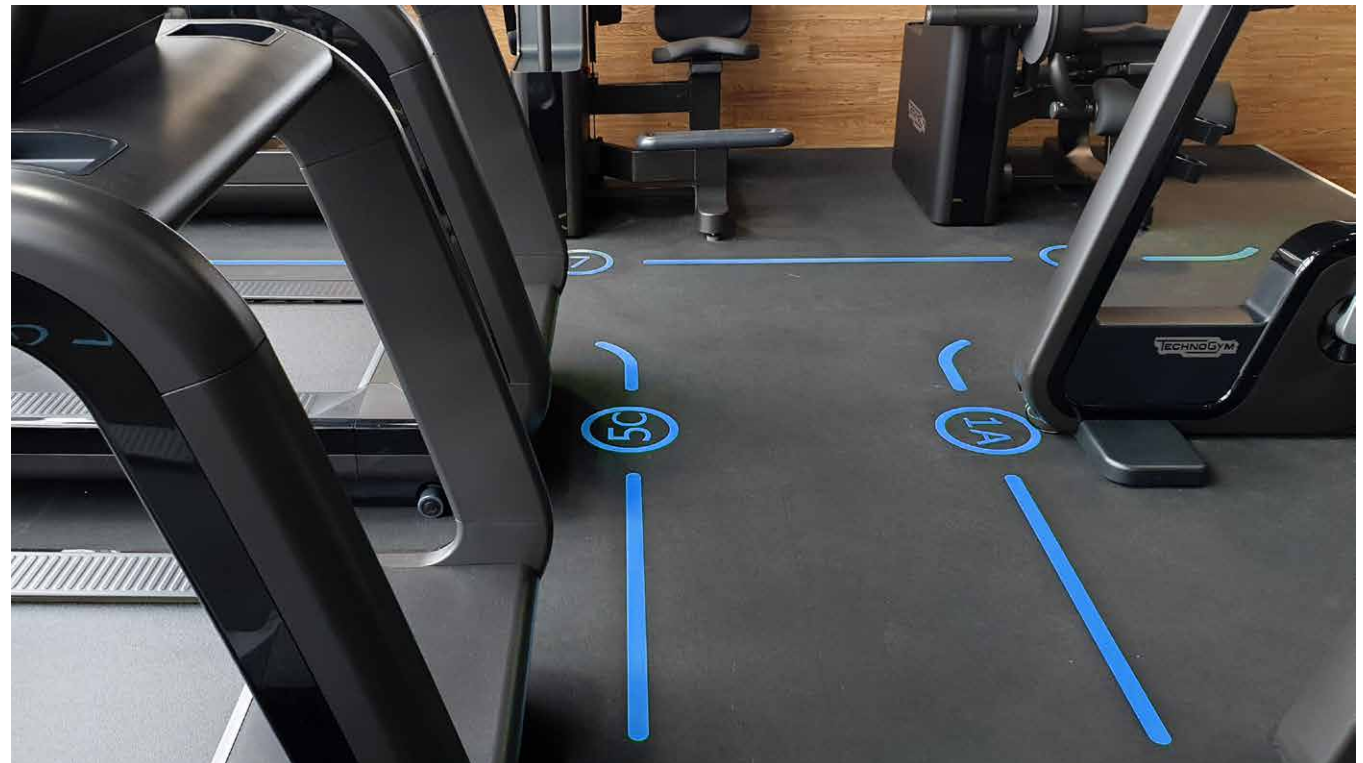

OUTDOOR Tiles

The highly shock-absorbent recycled rubber fitness tiles are manufactured and designed for each Open space and/or functional area manufactured and designed. The standard rubber tile has a 2-layer system; the bottom layer is made of coarse granules and the top layer of 5 mm, consists of finer granules.

These tiles are manufactured in the EU and are made exclusively from recycled European car tires, which are bound with PU. The two different floor structures are specially designed to channel (rain) water through and away from the training area.

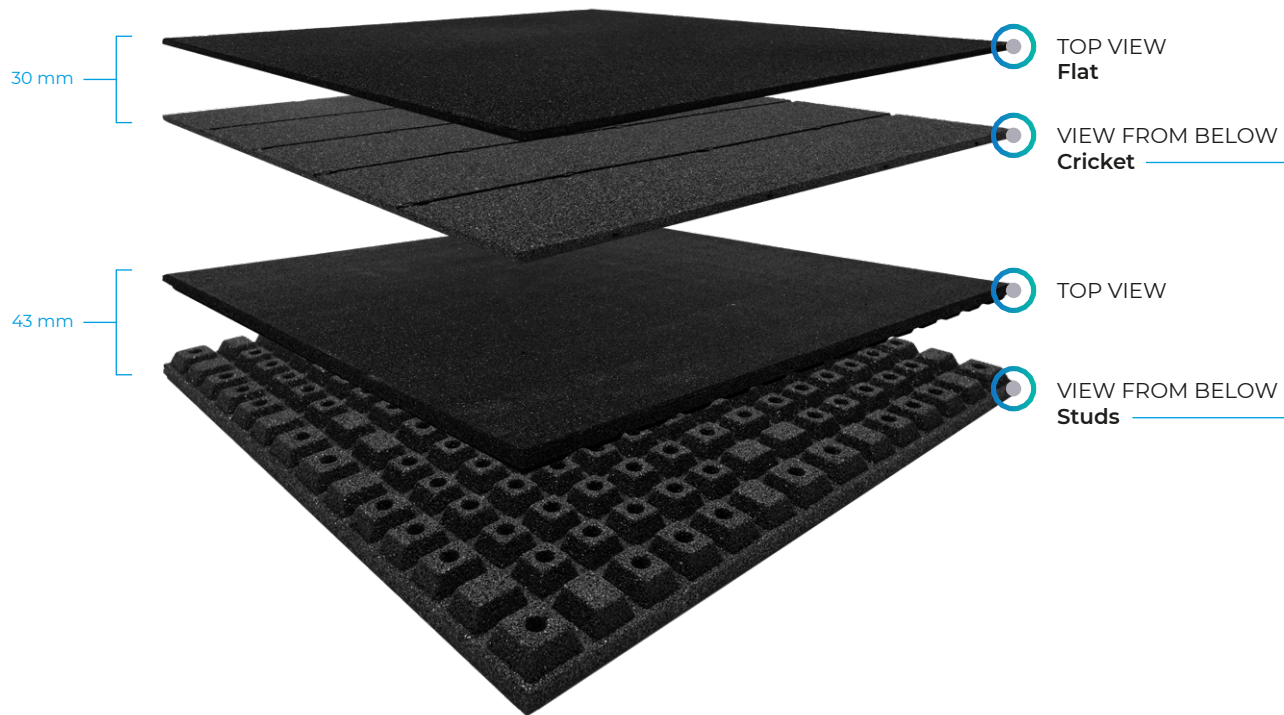

DIMENSIONS

All outdoor fitness plates are 1 x 1 meter in size. They are available in available in thicknesses of 30 and 43 mm.

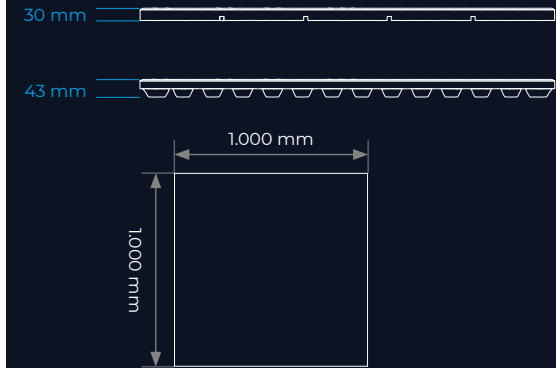

An almost closed floor surface with strategically placed drainage channels that give these variants excellent durability and ease of use.

Our studded floor is designed to withstand the toughest wear and tear while ensuring water drains efficiently through the many openings.

THE PEN SYSTEM

A pin hole is placed every 25 centimeters, resulting in an average of 4 pins per meter. This keeps the interconnected tiles firmly in place. This results in a phenomenal free-floating system that is achieved without glue or other complicated installation methods.

To visually minimize expansion and contraction of the tiles due to weathering we recommend closing the tile seams with an MS polymer adhesive.

CONNECTIONS

Our outdoor fitness tiles are easy to install with the pin connector system, no adhesive is required. The edges can be covered with a stainless steel profile. The tiles can be easily cut to the right size with a hand knife, we recommend the use of carpet knives (cutters) for this purpose.



Fig.: Outdoor Fitness Tile - 1.000x1.000x30 mm + PIN CONNECTORS

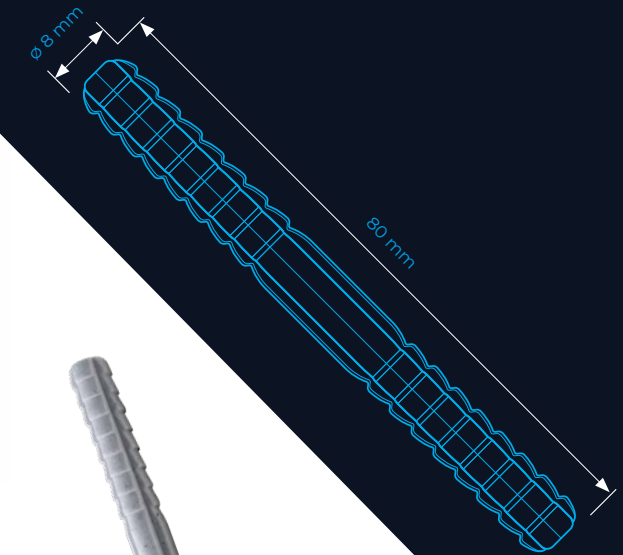

ADVANTAGES

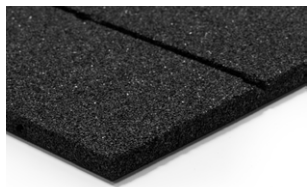

HIGH DENSITY



MADE IN EUROPE



100% RECYCLED RUBBER
USED



DESIGNED FOR OUTDOOR
USED



PUZZLE Tiles

The Sportsflooring puzzle tiles are made primarily from recycled black rubber particles from truck tires. the colored variants have a proportion of new EPDM in the a proportion of virgin EPDM. As a result of the exclusive of truck tires, this floor covering has a very fine and a very fine and smooth surface.

Our highly compact and maximally robust rubber floor covering is insensitive to moisture and humidity, rot-proof, elastic, impact sound absorbing and is suitable for a wide for a wide range of applications: Exhibitions, trade shows and booths, fitness centers, cross-training Boxes, recreation rooms, sports centers, dressing rooms, ice rinks, hill stations and many other facilities.

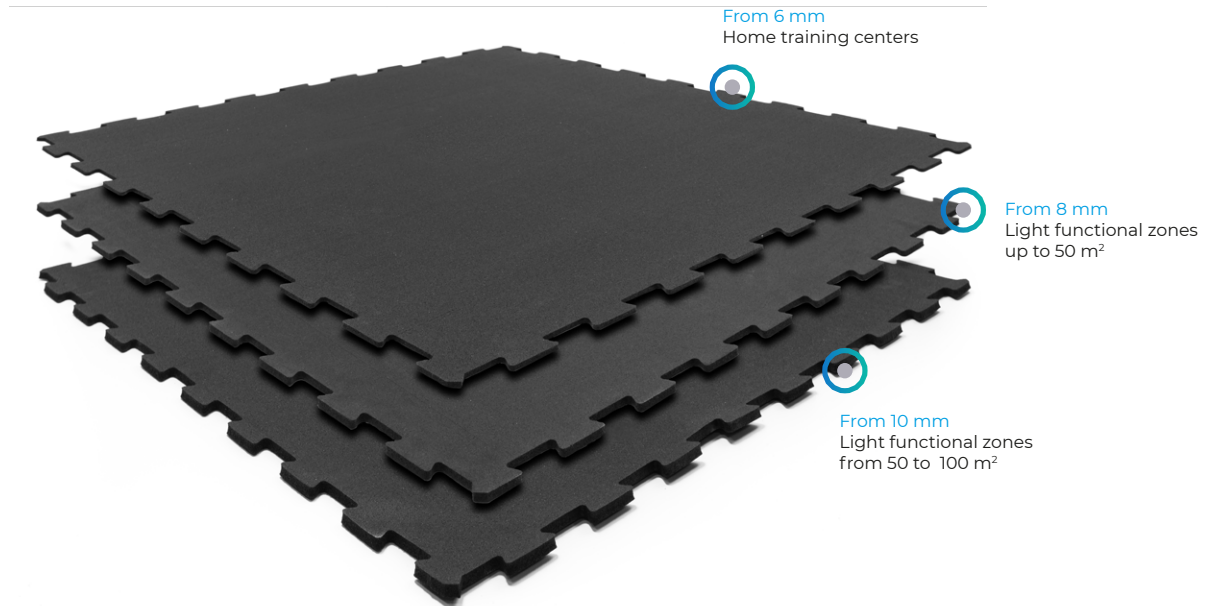

OUR COLOURS

PURE BLACK

SBR rubber granulate bonded with PUR

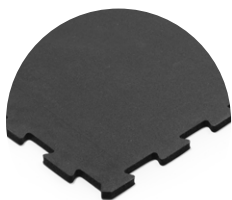

black

FIVE

95 % SBR and 5 % EPDM rubber granules, bonded with PUR



grey



blue



lila



orange



yellow



red



samba



stars

DENSITY

Our puzzle tiles are available in a thickness thickness suitable for any purpose.

From 6 mm up to 10 mm, in 2 mm increments. Our standard puzzle dimensions are 60 x 60 cm and 100 x 100 cm.

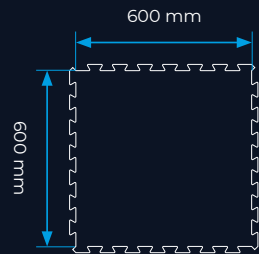
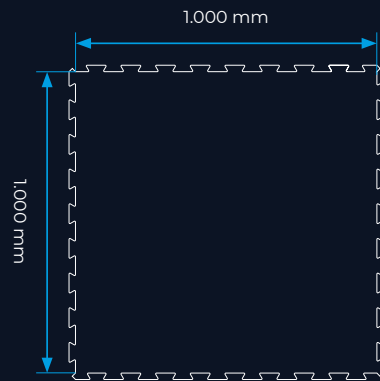

ADVANTAGES



INTERLOCKING PUZZLE SYSTEM



MADE IN EUROPE



100% RECYCLED RUBBER USED



ODORLESS







UP

PB
STEEL

Rig & Rack



PB STEEL Rig & Rack

DESIGN YOUR PB STEEL RIG & RACK NOW

Looking for a new centerpiece for your Functional Zone? Then PB Steel is the right modular RIG system for you.

Our RIGs are expandable, quickly deliverable and maximally flexible in design. Manufactured in Europe in close collaboration with design, product and training experts. Create your customized RIG (indoor as well as outdoor) with the highest level of flexibility and design. We deliver your RIG fast and reliable.



FEATURES

- Custom & Standard Options
- Maximum color variety
- Wide range of attachments
- High quality steel 80 x 80 mm / 4 mm thickness
- Ruggedness
- Laser cut & powder coated
- Logo branding
- Easy and fast installation
- Premium Quality
- Made in Europe

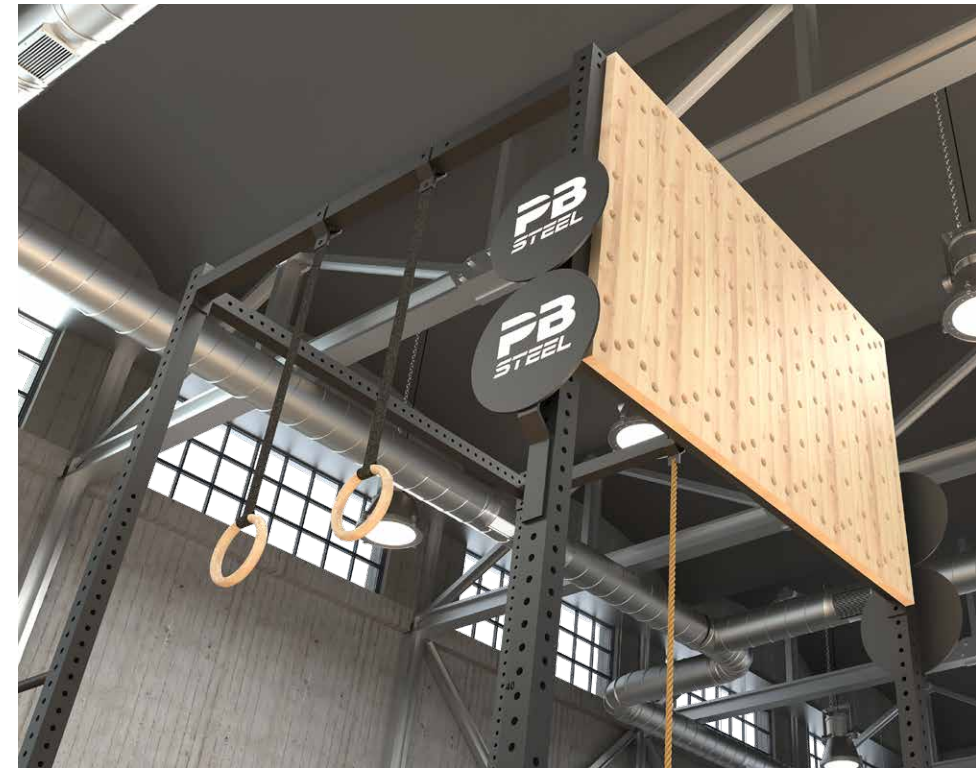

COLOR VARIETY



Black



Gray



Blue



Orange



Light red



Green



Yellow



Gold



Purple



Turquoise



Brushed



White

FEATURES

INDOOR RIGS

Coating warranty:	2 years
Steel warranty:	Lifetime
Warranty:	2 years
Outdoor:	No
Series:	Mighty
Dimensions:	80 x 80 mm
Material:	Steel
Width:	2704 mm
Height:	2750 mm
length:	3486,76 mm
SKU:	KB04MI-026

OUTDOOR RIGS

Coating:	Hot-dip galvanized and Powder coated
Coating warranty:	7 years
Steel warranty:	Lifetime
Outdoor:	Yes
Dimensions:	80 x 80 mm
Material:	Steel
Width:	4820 mm
Weight:	606 kg
Height:	4500 mm
length:	1700 mm
SKU:	KB01MI-011

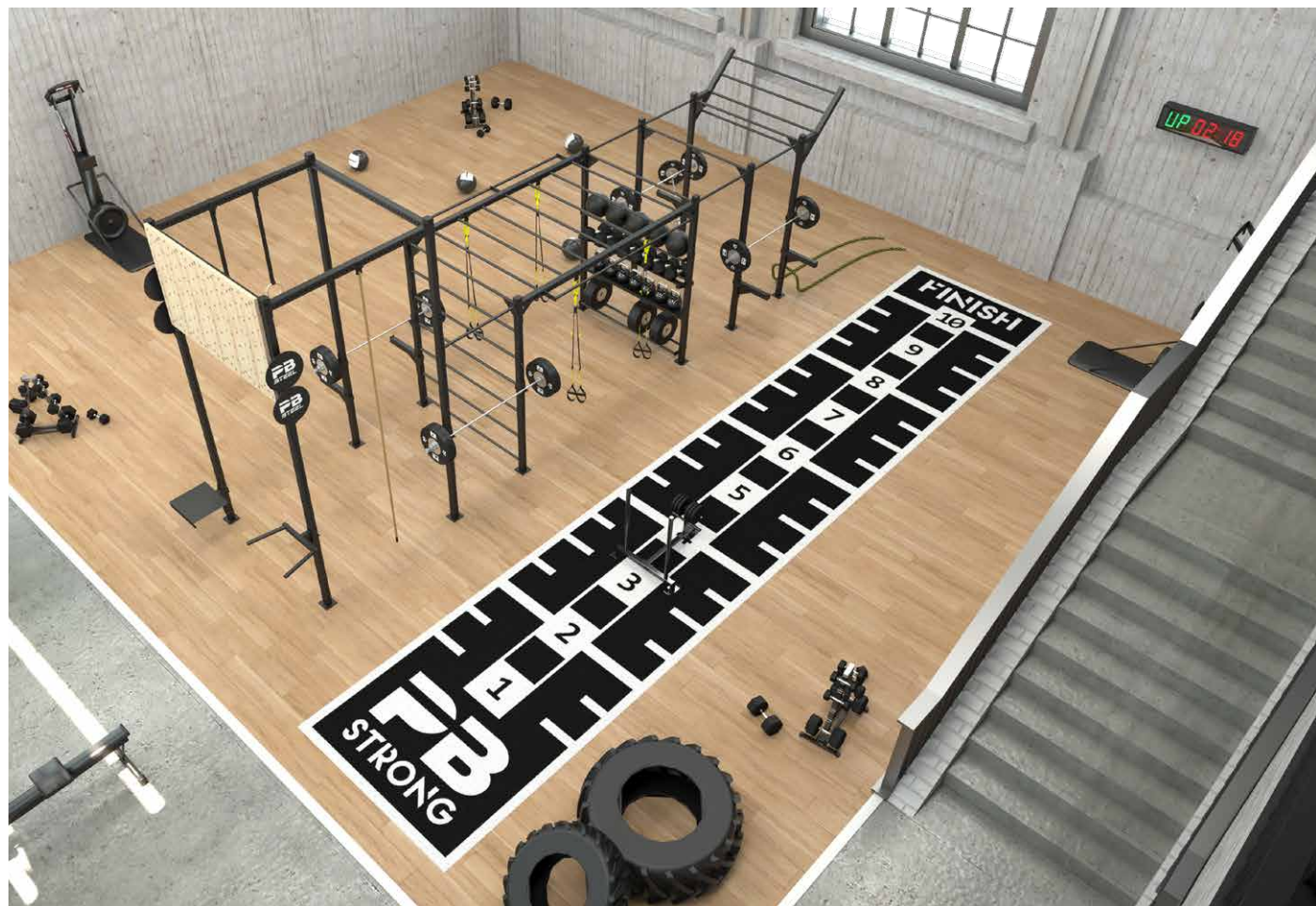

◎ PB STEEL – CLIMBING TOWER

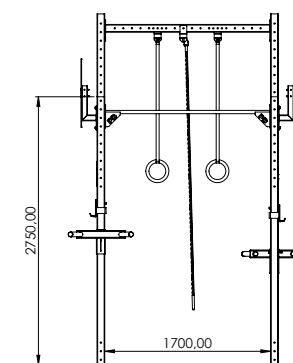
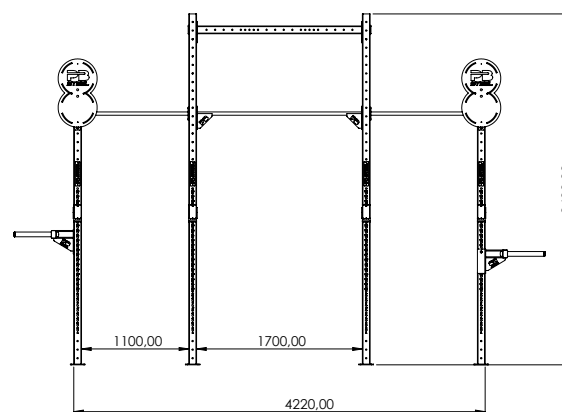

TOOLS

- 4 x Upright for Mighty Rig 275cm
- 4 x PU Bar S 1700
- 4 x PU bar S 1100
- 4 x Upright for Mighty Rig 360cm
- 4 x Universal Profile F 1700
- 3 x Iron Hand Mighty
- 4 x Mighty J-Cups
- 4 x Double WB Target
- 2 x Side Dip Bar

◎ PB STEEL – CROSS RIG

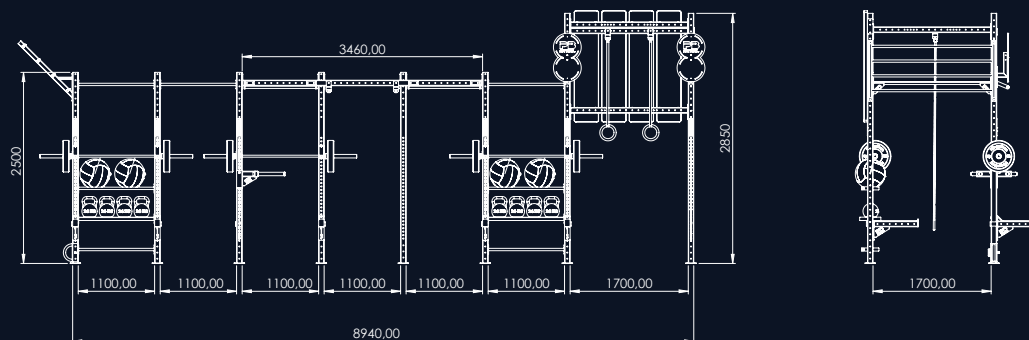
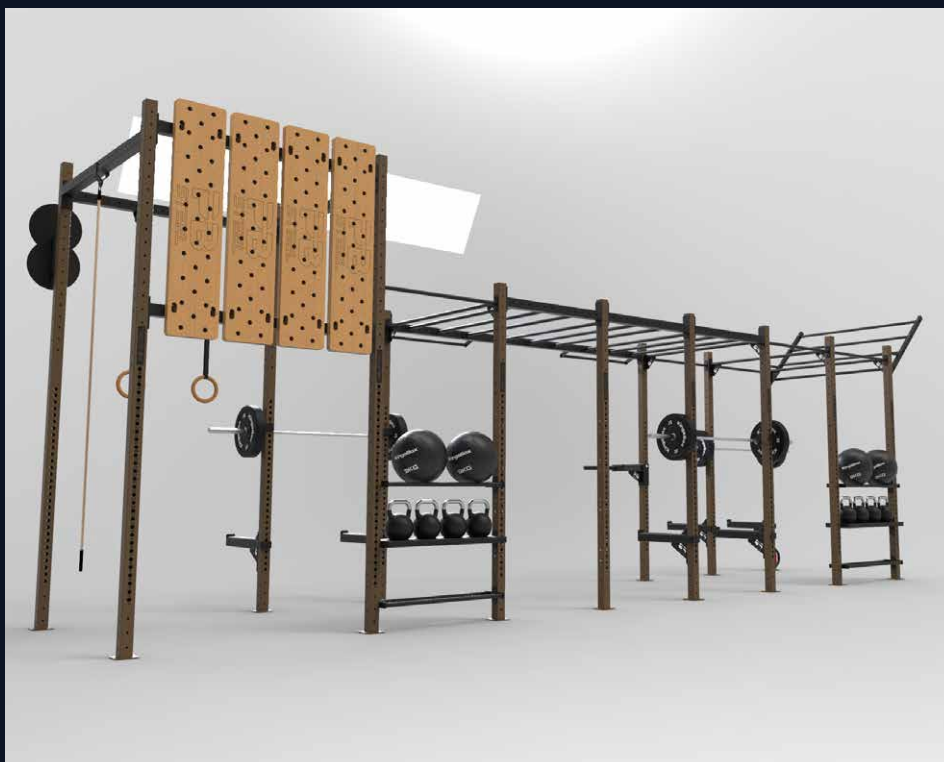

TOOLS

- 1 x Lestev za Rig 170cm (za Mighty Rig)
- 1 x Universal Profile F 3460
- 1 x Upright for Mighty Rig 2.0 360cm
- 1 x Rope Plezalna Vrv - 3m
- 1 x Kljuka za Battle Rope (Za Mighty Rig)
- 1 x Side Dip Bar
- 2 x Monkey Mount S PU Bar 1038
- 2 x Double WB Target
- 2 x Royal Wood Rings
- 3 x Universal Profile F 1100
- 3 x Upright for Mighty Rig 360cm
- 3 x Safety Arms
- 3 x Mighty J-Cups
- 4 x Upright for Mighty Rig 2.0 275cm
- 4 x Slamball Shelf 1100
- 5 x PU bar S 1100
- 5 x Universal Profile F 1700
- 5 x Iron Hand Mighty
- 6 x Upright for Mighty Rig 275cm
- 8 x KETTLEBELL 24KG
- 9 x PU Bar Monkey S 1700
- 4 x PU Bar S 1700
- 2 x Kettlebell Shelf 1100
- 4 x Rig Peg Board

◎ PB STEEL – CROSS RIG (PEGBOARD LATERAL)

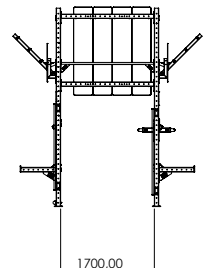
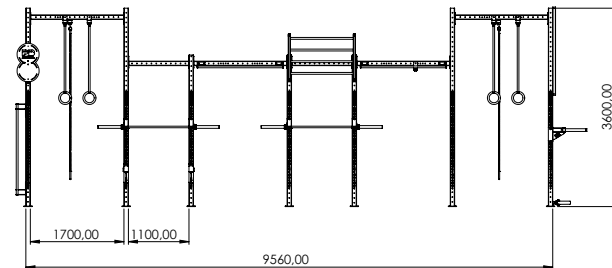

TOOLS

- 1 x Side Dip Bar
- 1 x Mighty Rig Landmine
- 2 x Double WB Target
- 2 x Lestev za Rig 110 cm (za Mighty Rig)
- 3 x PU Bar S 1700
- 4 x Royal Wood Rings
- 2 x Safety Arms
- 4 x Rig Peg Board
- 4 x Universal Profile F 1100
- 4 x Mighty J-Cups
- 6 x Monkey Mount S PU Bar 1566
- 8 x Upright for Mighty Rig 2.0 360cm
- 6 x Upright for Mighty Rig 275cm
- 8 x Iron Hand Mighty
- 10 x PU Bar Monkey S 1700
- 13 x Universal Profile F 1700

◎ PB STEEL – FITNESS RIG

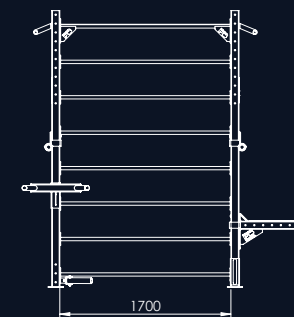
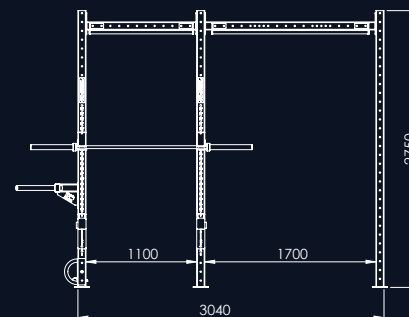

TOOLS

- 1 x Safety Arms
- 1 x Side Dip Bar
- 1 x Battle Rope Hook
- 1 x Mighty Rig Landmine
- 2 x Upright F 2750 Stall
- 2 x Universal Profile F 1100
- 2 x PU Bar S 1700
- 2 x Universal Profile F 1700
- 2 x Monkey Mount S PU Bar 1038
- 2 x Monkey Mount S PU Bar 1566
- 2 x Mighty J-Cups
- 4 x Upright for Mighty Rig 275cm
- 11 x PU Bar Monkey S 1700

◎ PB STEEL – FUNCTIONAL RIG

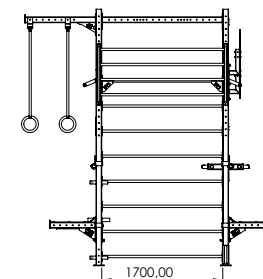
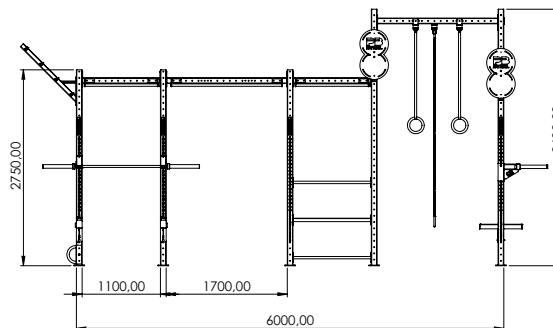

TOOLS

- 5 x Upright for Mighty Rig 275cm
- 3 x PU Bar S 1700
- 2 x Upright F 3600 Stall
- 6 x Universal Profile F 1700
- 2 x Upright for Mighty Rig 360cm
- 5 x Iron Hand Mighty
- 1 x Lestev za Rig 170cm (za Mighty Rig)
- 2 x Mighty J-Cups
- 16 x PU Bar Monkey S 1700
- 1 x Battle Rope Hook
- 2 x Double WB Target
- 1 x Side Dip Bar
- 2 x Safety Arms
- 1 x Upright F 2750 Stall
- 4 x Universal Profile F 1100
- 2 x Slamball Shelf 1100
- 1 x Kettlebell Shelf 1100
- 1 x Royal Branch F
- 1 x Mighty Plyo Platforma
- 2 x Monkey Mount S PU Bar 1566
- 3 x Monkey Mount S PU Bar 1038

◎ PB STEEL – TRAININGS TOWER

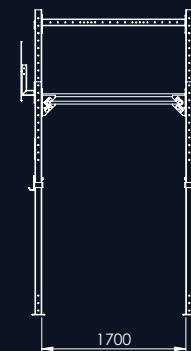
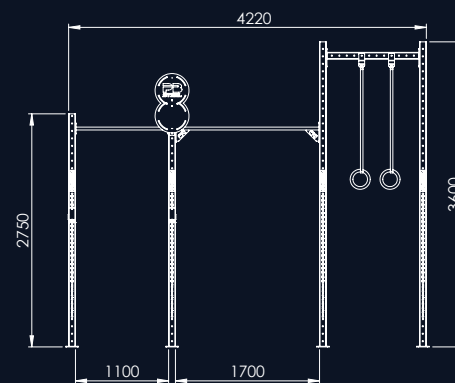

TOOLS

- 2 x PU bar S 1100
- 2 x Universal Profile F 1700
- 2 x Universal Profile F 1100
- 2 x Mighty J-Cups
- 4 x Upright for Mighty Rig 275cm
- 4 x Upright for Mighty Rig 360cm
- 4 x Iron Hand Mighty
- 4 x Royal Wood Rings
- 5 x PU Bar S 1700
- 1 x Double WB Target

◎ PB STEEL – WALL RIG

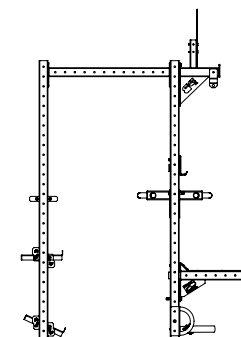
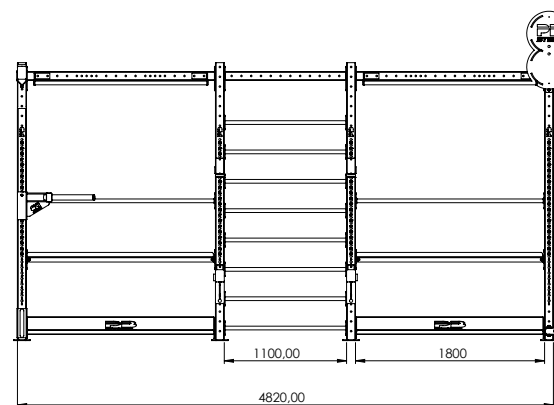

TOOLS

- 8 x Upright Rack Mighty 2500
- 8 x PU bar S 1100
- 6 x Universal Profile F 1100
- 4 x DB KB Shelf 1700
- 4 x Universal Profile F 1700
- 1 x PB Mini Branch F
- 1 x Iron Hand Mighty
- 1 x Battle Rope Hook
- 1 x Mighty Rig Landmine
- 1 x Safety Arms
- 1 x Mighty J-Cups
- 1 x Double WB Target
- 1 x Side Dip Bar
- 1 x Monkey Mount S PU Bar 1566

◎ PB STEEL – WEIGHT-LIFTING RIG

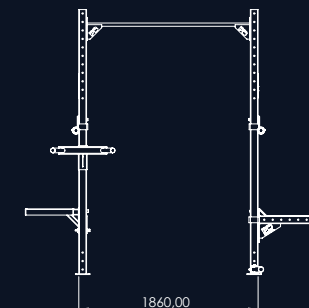
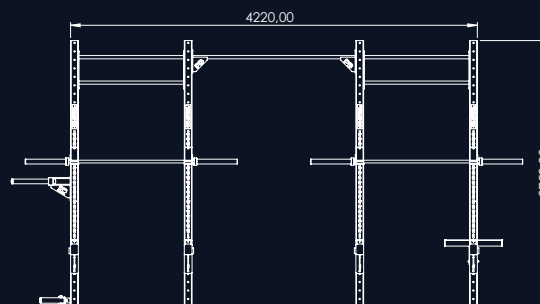
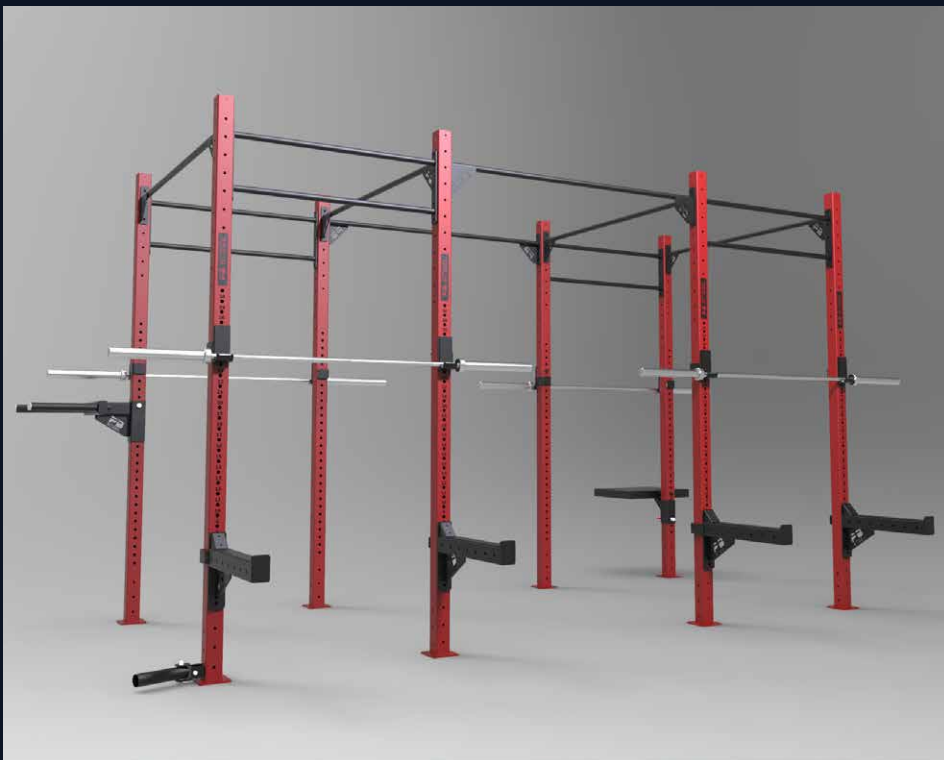

TOOLS

- 1 x Side Dip Bar
- 1 x Mighty Plyo Platform
- 1 x Mighty Rig Landmine
- 2 x Safety Arms
- 4 x PU Bar S Double 1100
- 4 x Mighty J-Cups
- 6 x PU Bar S 1700
- 8 x Upright for Mighty Rig 275cm

◎ PB STEEL – FITNESS Rack

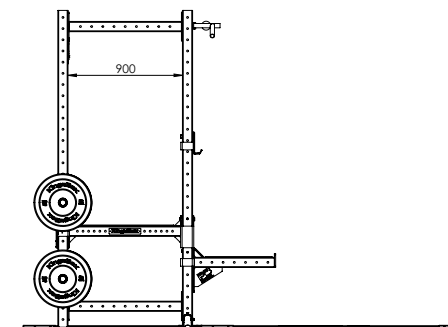
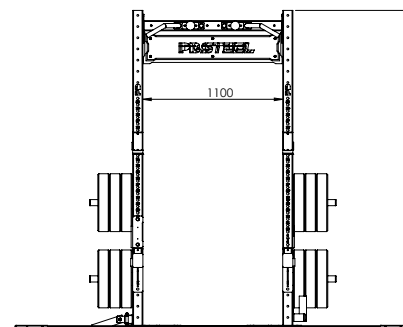
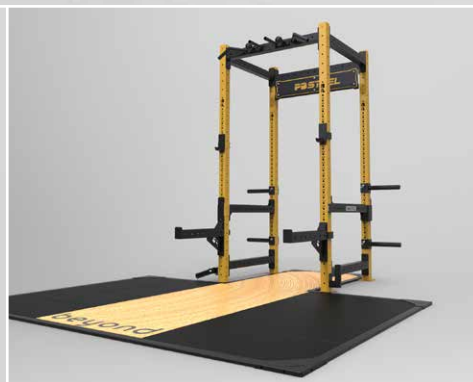

TOOLS

- 1 x Universal Profile F 1100
- 1 x Manifesto Sign III
- 1 x Monkey Profile 1100 F
- 1 x PB Sign Text Plate
- 1 x Modular Angled S Grip L
- 1 x Modular Angled S Grip D
- 1 x Mighty J-Cups
- 1 x Mighty Rig Landmine
- 1 x One Bar Rack BL
- 1 x Rack Platform
- 1 x Mighty Safety Catchers 900
- 1 x Safety Arms
- 2 x Modular Neutral S Grip
- 2 x PU 70 Sphere S
- 4 x Upright Rack Mighty 2500
- 4 x Linked profile 900F
- 4 x Mighty Mortar Bumper Rack

PERFORM BETTER



FTC Functional Training Company GmbH
Perform Better Europe
Pelkovenstr. 148 / D-80992 München

Telefon: +49 (0) 89 4444679-250
E-Mail: info@perform-better.de

www.perform-better.de | www.pb-institute.de
www.perform-corporate.de | www.perform-digital.de